



TOSHIBA

The power to open people's eyes

29VH36/37

Owners Manual

Contents

For your safety	1
Installation of TV Set	2
Preparation	2
Before Switching on your TV	2
Power connection	2
Aerial Connections	2
How to connect the external equipments	2
Inserting batteries in the remote control handset	2
Control Panel Buttons	3
Antenna Connections	3
Remote Control Buttons	4
Features	5
Switching the TV ON/OFF	5
To switch the TV on	5
To switch the TV off	5
Initial Settings	5
Operating with the onset buttons	5
Operating with Remote Control	6
Menu System	6
Sound menu	6
Picture menu	8
Feature menu	9
Installation Menu	9
Other Functions	11
Sound Mute	11
Stereo / Bilingual	11
Information on Screen	11
Manual Selection of External Source	11
Screen Format	11
Previous Program Selection	11
Sound Standard Selection	11
To Display the Time	11
Picture Mode	11
Still Picture	12
Teletext	12
To operate Teletext	12
To select a page of Teletext	12
To Select Index Page	12
Searching for a page while watching TV	12
To Select Double Height Text	12
To Reveal "concealed" Information	12
To Stop Automatic Page Change	12
Split Screen	12
To exit Teletext	12
Fastext	12
Connect the External Equipments	13
Connect the External Equipments	14
Via the Euroconnector	14
RGB mode	14
S-VHS	14
S-VHS EXT2 Mode	14
Via the RCA jacks	14
Via the ANT (aerial) socket	14
TV and Video Recorder (VCR)	14
NTSC Playback	14
Copy Facility	14
Connecting Headphones	14
Tips	14
Cleaning The Screen	15
Exclusion Clause	15
Specifications	15

For your safety

This equipment has been designed and manufactured to meet international safety standards but, like any electrical equipment, care must be taken if you are to obtain the best results and safety is to be assured. So, please read the points below for your own safety. They are of a general nature, intended to help you with all your electronic consumer products and some points may not apply to the goods you have just purchased.

Some "DOs" and "DON'Ts" for you

Air Circulation...

Leave at least 10cm clearance around the television to allow adequate ventilation. This will prevent the TV from overheating and consequential possible damage to the TV. Dusty places should also be avoided.

Heat Damage...

Damage may occur if you leave the TV in direct sunlight or near a heater. Avoid places subject to extremely high temperatures or humidity, or locations where the temperature is likely to fall below 5°C (41°F).

Hot / Moderate Climate Conditions

This device is suitable for working in hot and moderate climate conditions.

Mains Supply...

The mains supply required for this equipment is **230V AC, 50 Hz**. Never connect to a DC supply or any other power source. DO ensure that the TV is not standing on the mains lead. DO NOT cut off the mains plug from this equipment, this incorporates a special Radio Interference Filter, the removal of which will impair its performance.
IF IN DOUBT PLEASE CONSULT A COMPETENT ELECTRICIAN.

DO...

DO read the operating instructions before you attempt to use the equipment.

DO ensure that all electrical connections (including the mains plug, extension leads and inter-connections between pieces of equipment) are properly made and in accordance with the manufacturers' instructions.

Switch off and withdraw the mains plug before making or changing connections.

DO consult your dealer if you are ever in doubt about the installation, operation or safety of your equipment.

DO be careful with glass panels or doors on equipment.

DO NOT...

DON'T remove any fixed cover as this may expose dangerous voltages.

DON'T obstruct the ventilation openings of the equipment with items such as newspapers, table-cloths, curtains etc. Overheating will cause damage and shorten the life of the equipment.

DON'T allow electrical equipment to be exposed to dripping or splashing or objects filled with liquids, such as vases, to be placed on the equipment.

DON'T place hot objects or naked flame sources, such as lighted candles or nightlights on, or close to the equipment. High temperatures can melt plastic and lead to fires.

DON'T use makeshift stands and **NEVER** fix legs with wood screws. To ensure complete safety, always fit the manufacturer's approved stand or legs with the fixings provided according to the instructions.

Place on a sturdy platform, the mounting surface should be flat and steady, it should then be secured to the wall with a sturdy tie using the hook on the back of the TV, this will prevent it from falling over.

DON'T listen to headphones at high volume, as such use can permanently damage your hearing.

DON'T leave equipment switched on when it is unattended, unless it is specifically stated that it is designed for unattended operation or has a standby mode. Switch off using the switch on the equipment and make sure your family know how to do this. Special arrangements may need to be made for infirm or handicapped people.

DON'T continue to operate the equipment if you are in any doubt about it working normally, or it is damaged in any way – switch off, withdraw the mains plug and consult your dealer.

DON'T put the empty batteries into garbage instead of recycle bin to reduce harmful effects to the environment.

ABOVE ALL – NEVER let anyone, especially children, push anything into holes, slots or any other openings in the case – this could result in a fatal electric shock.

NEVER guess or take chances with electrical equipment of any kind – it is better to be safe than sorry.

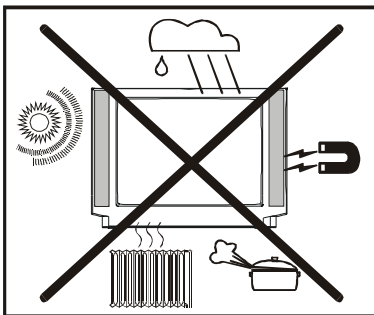
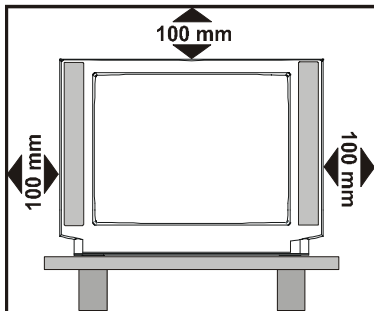

TO FULLY DISCONNECT THE TV, SWITCH OFF THE MAINS SOCKET AND REMOVE THE POWER PLUG.

Installation of TV Set

Preparation

Place the TV on a solid surface.

For ventilation, leave a space of at least 100mm. Free all around the set.

To prevent any fault and unsafe situations, please do not place any objects on top of the set.

Before Switching on your TV

Power connection

Important: The TV set is designed to operate on **230 V AC, 50 Hz.**

- After unpacking, allow the TV set to reach the ambient room temperature before you connect the set to the mains.

Aerial Connections

- Connect the aerial plug to the aerial input socket located at the back of the TV.

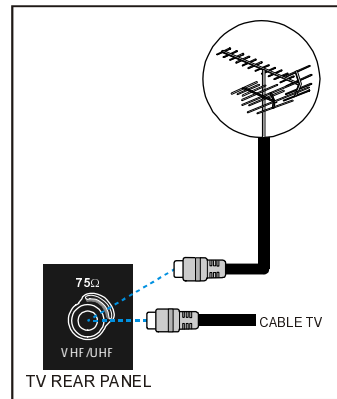

How to connect the external equipments

See "Connect the External Equipments" on page 13.

- See the instruction manuals provided with the external devices too.

Inserting batteries in the remote control handset

- Remove the battery cover located on the back of the handset by gently pulling upwards from the indicated part.
- Insert two **AAA (R03)** or equivalent type batteries inside.
- Replace the battery cover.

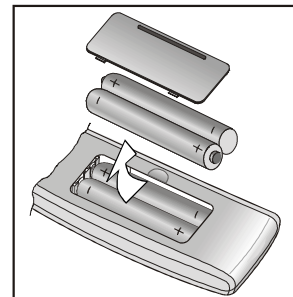

NOTE: Remove batteries from remote control handset when it is not to be used for a long period. Otherwise it can be damaged due to any leakage of batteries.

Dispose of them in a designated disposal area.

Control Panel Buttons

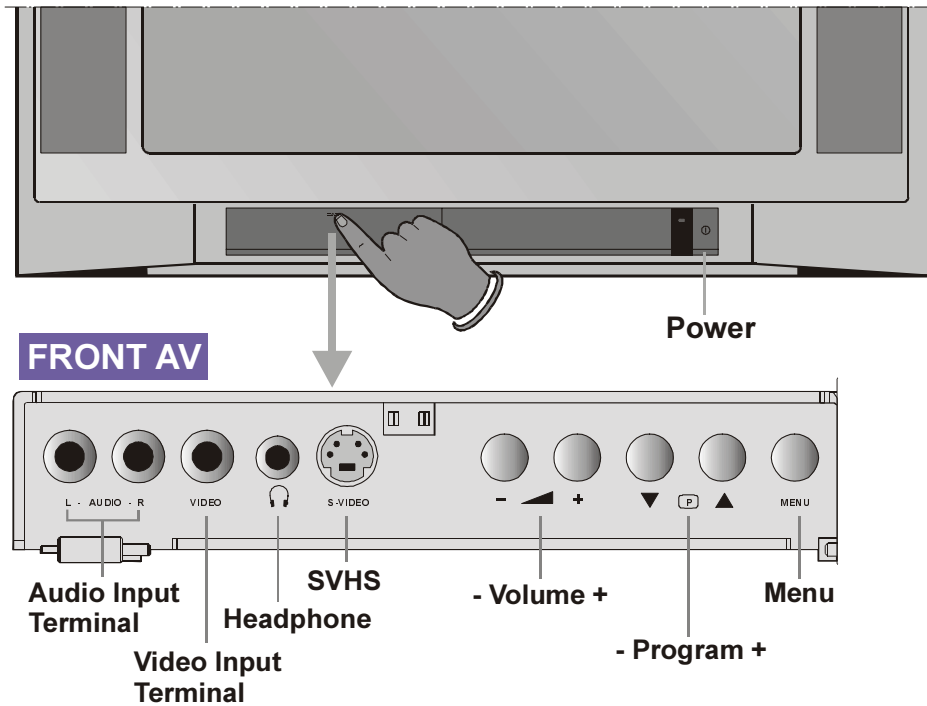

Antenna Connections

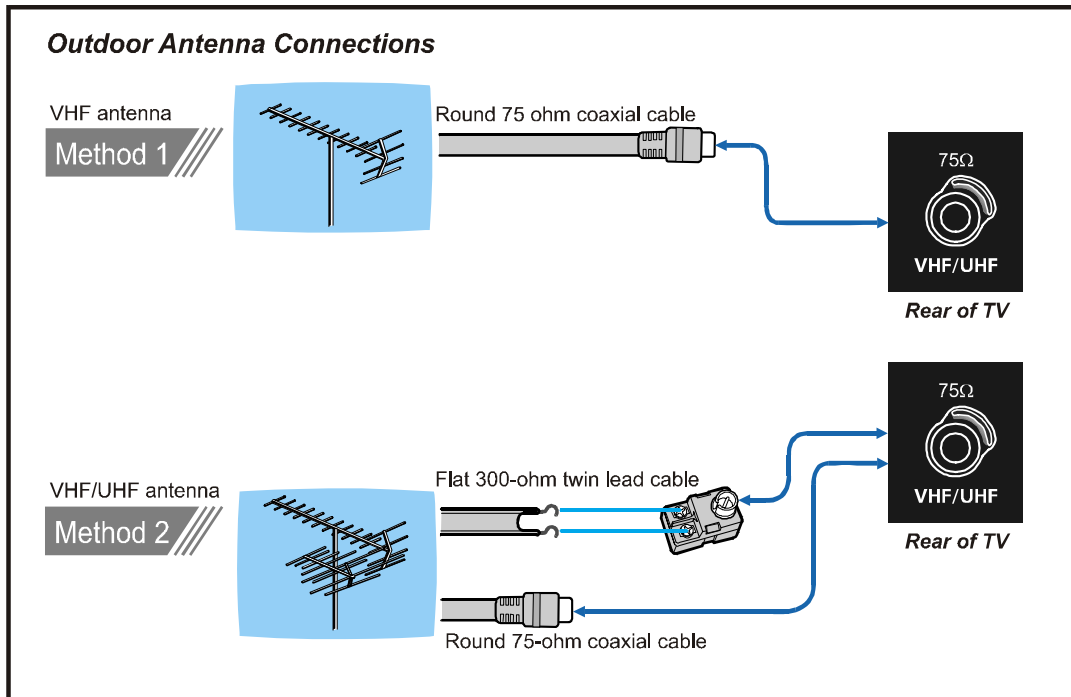

Remote Control Buttons

- ① = Stand By
- ② **0 - 9** = Direct Program
- ③ = External Source
(EXT-1, EXT-2, EXT-3, S-VHS, S-VHS EXT2, FRONT-AV)
- ④ **PP** = Picture Mode Selection
- ⑤ **EXIT** = TV / AV / TEXT / MENU Quit
- ⑥ = Programme Up / Cursor Up
- ⑦ = Volume Up / Cursor Right
- ⑧ = Programme Down / Cursor Down
- ⑨ **V - / V +** = Volume Down / Volume Up
Cursor Left / Cursor Right
- ⑩ **Yellow** = Feature Menu
- ⑪ **Blue** = Install Menu
- ⑫ = Teletext / Mix / Teletext Quit
- ⑬ = Time / Update
- ⑭ = Hold
- ⑮ = Index Page
CALL = TV Status
- ⑯ = No Function
- ⑰ = No Function
- ⑱ = Reveal
- ⑲ = Expand
- ⑳ = Picture Mode (Auto, 4:3, 16:9)
- ㉑ = Stereo / Mono / Dual I-II
- ㉒ **Red** = Sound Menu
- ㉓ **Green** = Picture Menu
- ㉔ = Volume Down / Cursor Left
- ㉕ **OK** = Ok
- ㉖ **MENU** = Menu
- ㉗ = Programme Swap
- ㉘ = Mute

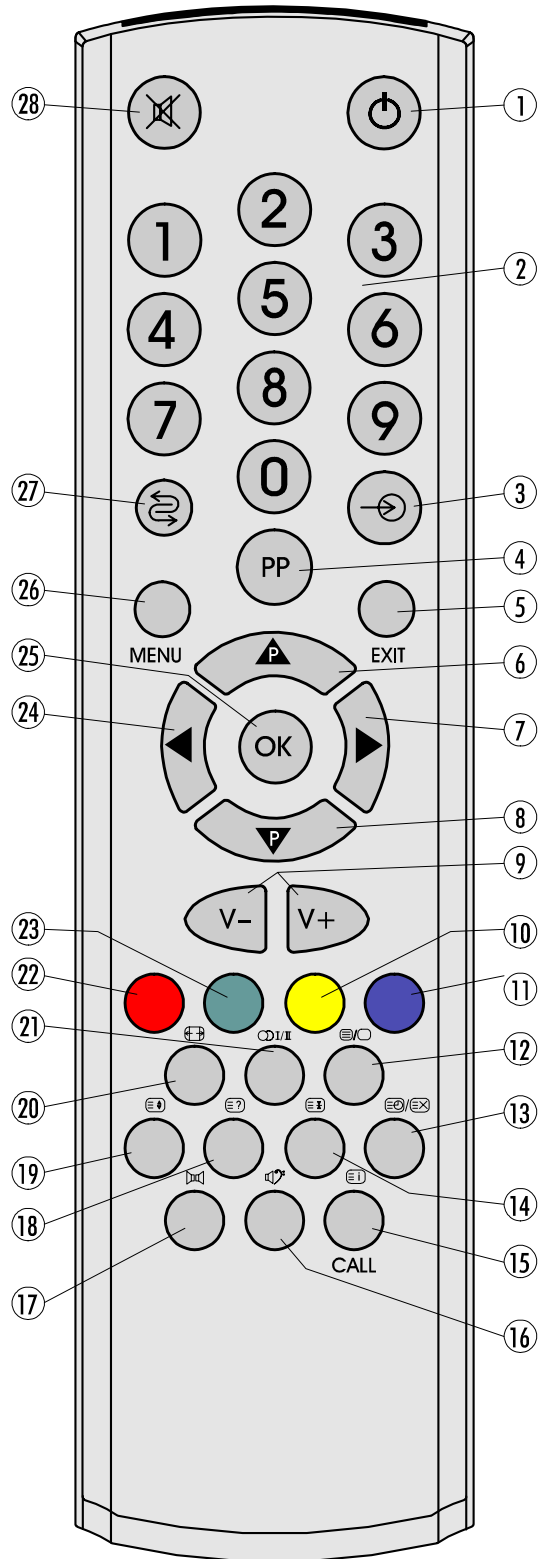

*Functions of the “◀” / “▶” and “-V / V+” buttons are the same.

Features

- Infra red remote control
- 100Hz flicker free
- User friendly menu system
- On-screen functional display
- Frequency synthesis tuning
- Comb filter
- Sleep timer
- 100 program storage locations
- S-band (S1-S20)
- Hyper band reception (S21-S41)
- Digital-CTI (Color Transient Improvement)
- Digital noise reduction
- Auto, 4:3, 16:9
- Built-in 2 speakers
- Volume controlled Headphone output, and headphone terminals (jacks)
- Balance control
- 5-Band equaliser
- 3 x Euro AV plug (Scart)
- 75 Ohm Aerial socket
- Fastext
- German + Nicam Stereo
- Real Flat (Dynamic Focus)
- S-VHS (via SCART or SVHS connector)
- Front-AV
- Multi system reception (PAL SECAM B/G D/K L/L')
- NTSC Playback
- Automatically switch off after 5 minutes when no signal.
- Automatic VCR detection
- Digital Scan

Switching the TV ON/OFF

You can operate your TV either using the remote control handset or directly using the TV onset buttons.

To switch the TV on

Your TV will switch on in two steps:

1- Press the power button located on the front of the TV. Then the TV switches itself to standby mode and the **RED LED** located below the TV turns on.

2- To switch on the TV from stand-by mode either:

Press a digit button on the remote control so that a programme number is selected,

or,

Press Standby / Power Button or Programme Up and Down buttons on the front of the TV or on the remote control respectively, so the TV will switch on and the **RED** Led will turn **GREEN**.

IMPORTANT:

- If no aerial signal is received at the selected program for a period of 5 minutes then your TV automatically switches into stand-by mode.

To switch the TV off

- Press the stand-by button on the remote control, so the TV will switch to stand-by mode and the **GREEN LED** will become **RED**, or,
- Press the power button located on the front of the TV.

NOTE: If you have switched off the TV set from the power button instead of the remote control, next time you press the power button, the TV set will switch on without going to the stand-by mode.

Initial Settings

The message "**PLEASE CHECK ANTENNA CABLE!**" will be displayed when you turn on your TV for the first time.

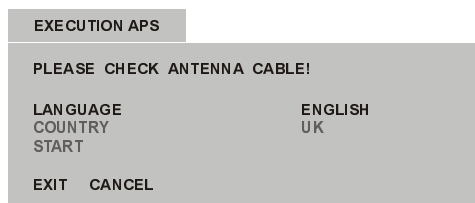

Note: If you connect Video Recorder to your TV via antenna input (ANT socket); to tune the VCR channel automatically you must set the VCR in play mode before you start APS.

- 1- Select **LANGUAGE** with "**▲**" or "**▼**" button, then press the "**◀**" or "**▶**" button to select a menu language.
- 2- Select **COUNTRY** with "**▲**" or "**▼**" button, then press the "**◀**" or "**▶**" button to select the correct country.
- 3- Select **START** with "**▲**" or "**▼**" button, then press the "**▶**" button to start **APS**.

APS, (Automatic Programming System) automatically programmes the received channels in your TV's programme numbers. During **APS**, "**APS IS RUNNING PLEASE WAIT**" message will be displayed. After **APS** is finalized, the "**PROGRAM TABLE**" appears.

To cancel **APS**, press the "**EXIT**" button.

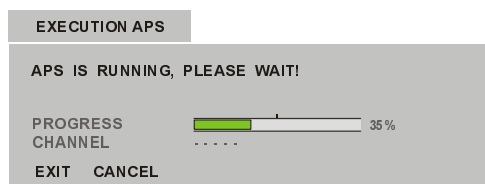

PROGRAM TABLE		
1	11	21
2	12	22
3	13	23
4	14	24
5	15	25
6	16	26
7	17	27
8	18	28
9	19	29
10	20	30

change delete

Operating with the onset buttons

Volume setting and programme selection can be made using the buttons on the front panel.

Volume Setting

- Press "**-**" button to decrease volume or "**+**" button to increase volume, so a volume level scale will be displayed on the screen.

Programme Selecting

- Press “**P** ▲” button to select next programme or “▼ **P**” button to select the previous programme.

Entering Main Menu

- Press “**MENU**” button to enter the menu. In the menu select sub-menu using “▲ +” or “- ▲” buttons and enter the submenu using “▼ **P**” button. In the submenu select the desired item by using “**P** ▲” or “▼ **P**” buttons and to change or adjust it using “▲ +” or “- ▲” buttons. To learn the usage of the menus, refer to the Menu System section.

Operating with Remote Control

The remote control handset of your TV is designed to control all the functions of the model you selected. The functions will be described in accordance with the menu system of your TV.

Functions which you can use out of menu system are described below.

Volume Setting

Press “**V+**” button to increase volume.

Press “**V-**” button to decrease volume.

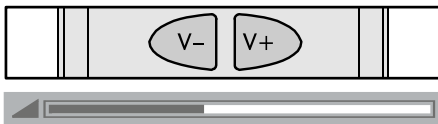

Programme Selecting (Previous or next programme)

- Press “▼” button to select the previous programme.
- Press “▲” button to select the next programme.

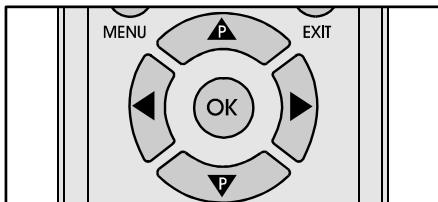

Programme Selecting (direct access):

Press digit buttons on the remote control handset to select programmes between 0 and 9. TV will switch to the selected program after a short delay.

- For a two digit program number enter the second digit after pressing the first digit within 2 seconds.

Menu System

Your TV has been designed with a menu system to provide an easy manipulation of a multifunction system. “**MENU**” button has two functions. The first function of it is opening and closing the menu, the second function is closing the submenu and then opening its parent menu. The short way in order to enter the menus, press:

“ MENU ” button	Menu
Red button	Sound menu
Green button	Picture menu
Yellow button	Feature menu
Blue button	Installation menu

When you press “**MENU**” button, the following menu appears on the screen.



Press “◀” or “▶” button to select a menu title and then “▼” or “**OK**” button to enter the menu.

Sound menu

First icon belongs to the sound menu. By pressing “▼” or “**OK**” button, Sound menu appears on the screen.

You can enter Sound menu directly by pressing **RED** button.

Volume

When you entered the sound menu Volume will be the first selected item. Press “▶” button to increase volume level. Press “◀” button to decrease volume level.

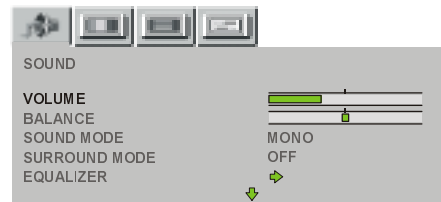

Balance

By pressing “▲” or “▼” button, select Balance. Press “▶” button to move balance rightward. Press “◀” button to move balance leftward.

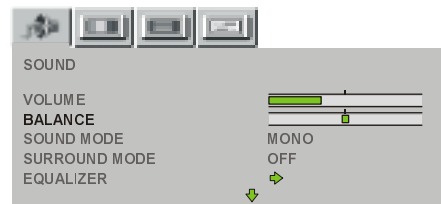

Sound Mode:

By pressing “▲” or “▼” button, select Sound Mode. You can change the sound mode to **MONO**, **STEREO**, **DUAL - 1** or **DUAL - 2** by pressing “◀” or “▶” button.



Surround Mode

By pressing “▲” or “▼” button, select Surround Mode. You can change the surround mode to ***INCR. STEREO (INCR. MONO)** or **OFF** by pressing “◀” or “▶” button.

* **INCR.:** Incredible



Equalizer

By pressing “▲” or “▼” button, select Equalizer. Press “▷” button to enter equalizer menu. In equalizer menu the sound style can be changed to **USER, NORMAL, SPEECH, MUSIC** or **MOVIE** by pressing “◀” or “▶” button. When equalizer menu settings are changed sound style switches to **USER**.

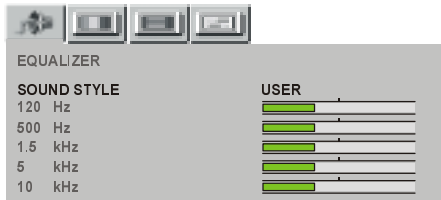

By pressing “▼” button, the required frequency is selected and by “◀” or “▶” buttons the frequency gain can be increased or decreased. Press “OK” button to store Equalizer menu settings. Press “MENU” button to exit the equalizer menu.

Headphone Menu

By pressing “▲” or “▼” button, select Headphone. Press “▶” button to enter Headphone menu.



Volume

By pressing “▲” or “▼” button, select Volume. Press “▶” button to increase headphone volume level. Press “◀” button to decrease headphone volume level.



Balance

By pressing “▲” or “▼” button, select Balance. Press “▶” button to move headphone balance rightward. Press “◀” button to move headphone balance leftward.

Sound Mode

By pressing “▲” or “▼” button, select Sound Mode. You can change the sound mode to **MONO, STEREO, DUAL - 1** or **DUAL - 2** by pressing “◀” or “▶” button.

To Store the Settings

- Press “OK” button to store Headphone menu settings.
- “STORED” will be displayed.

Bass Boost

Bass Boost is used to increase bass effect of the TV set.

By pressing “▲” or “▼” button, select Bass Boost. You can set the Bass Boost to **ON** or **OFF** by pressing “◀” or “▶” button.

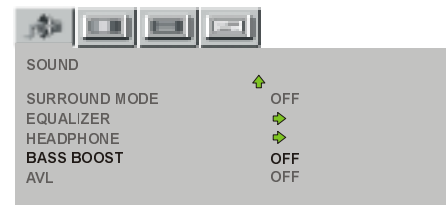

AVL

Automatic Volume Limiting (AVL) function normalizes sound to obtain fixed output level between programs, having different sound levels. Pressing “◀” or “▶” button will turn **ON** or **OFF** this feature.

To Store the Settings

- Press “OK” button to store Sound menu settings.
- “STORED” will be displayed.

Picture menu

By pressing “◀” or “▶” button, select the second icon.



By pressing “▼” or “OK” button, Picture menu appears on the screen.

You can enter Picture menu directly by pressing **GREEN** button.

Setting Brightness

When you entered the Picture menu Brightness will be the first selected item. Press “▶” button to increase Brightness level. Press “◀” button to decrease Brightness level.



Setting Contrast

- Using “▲” or “▼” button select Contrast.
- Press “▶” button to increase contrast level.
- Press “◀” button to decrease contrast level.



Setting Color

- Using “▲” or “▼” button select Color.
- Press “▶” button to increase color level.
- Press “◀” button to decrease color level.

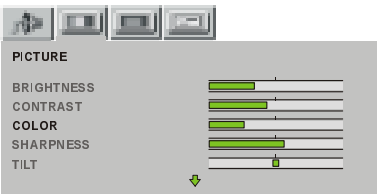

Setting Sharpness

- Using “▲” or “▼” button select Sharpness.
- Press “▶” button to increase sharpness level.
- Press “◀” button to decrease sharpness level.

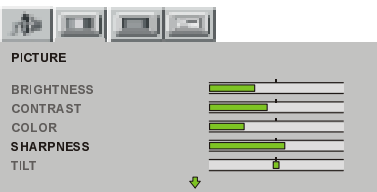

Setting Tilt

- Using “▲” or “▼” button select Tilt.
- Press “▶” button to increase tilt level.
- Press “◀” button to decrease tilt level.



Setting Tint

This item is used to change the Color Temperature. By pressing “◀” or “▶” button you may select one of these options: **COOL, WARM, NORMAL.**

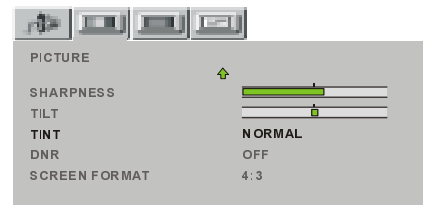

DNR

By pressing “▲” or “▼” button, select DNR. You can change the DNR (Digital Noise Reduction) to **MINIMUM, MEDIUM, MAXIMUM** or **OFF** by pressing “◀” or “▶” button.

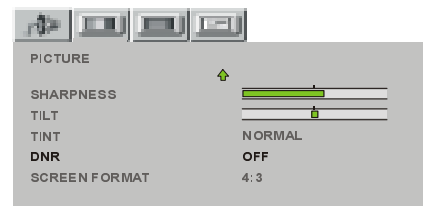

Setting Hue (In AV mode only)

(This appears in AV mode only when an NTSC video source is applied. Otherwise, HUE option is invisible in Picture menu.):

- Using “▲” or “▼” button select Hue.
- Press “▶” button to increase hue level.
- Press “◀” button to decrease hue level.

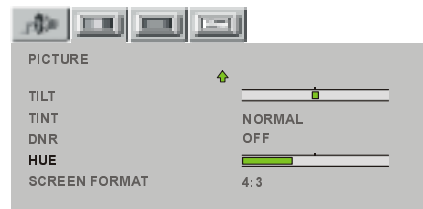

Screen Format

By pressing “▲” or “▼” button, select Screen Format. You can change the screen format to **AUTO, 4:3** or **16:9** by pressing “◀” or “▶” button.

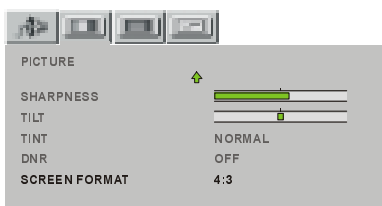

Screen Format can be set by "◀▶" wide mode button also.

To Store the Settings

- Press "OK" button to store Picture menu settings.
- "STORED" will be displayed.

Feature menu

By pressing "◀" or "▶" button select the third icon.



By pressing "▼" or "OK" button, Feature menu appears on the screen.

You can enter Feature menu directly by pressing YELLOW button.

Sleep Timer

As you enter the **Feature** menu, **Sleep Timer** will be the first selected option. Use "◀" or "▶" button to change the Sleep Timer values between **OFF, 15 MIN, 30 MIN, 45 MIN, 60 MIN, 90 MIN, 120 MIN, 150 MIN** and **180 MIN**.

If sleep timer is activated, at the end of the selected time, the TV goes automatically to stand-by mode.

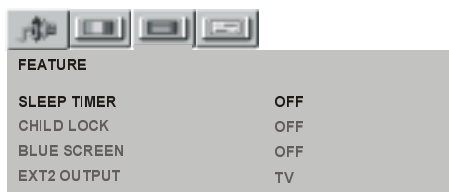

Child Lock

You can use this feature to prevent children turning on TV or changing programs or adjustments etc. without remote control.

The **Child Lock** feature can be set by "◀" or "▶" button to either **ON** or **OFF**. When **OFF** is selected, there will be no difference in the operation of your TV. When **ON** is selected, the TV can only be controlled by the remote control handset. In this case, the front panel buttons (except the Power On/Off button) will not work.

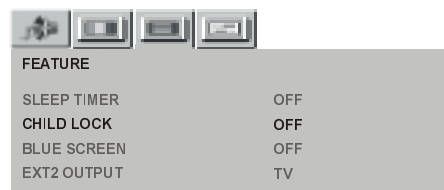

While the **CHILD LOCK** is **ON**, pressing any of the front/right panel buttons (except Power on/off button) causes the warning menu to appear on the middle of the screen.

CHILD LOCK

Blue Screen

In case, no valid signal is detected (in TV or AV mode) Blue Screen is activated. During search process Blue Screen is not active.

The **Blue Screen** feature can be set by "◀" or "▶" button to either **ON** or **OFF**.

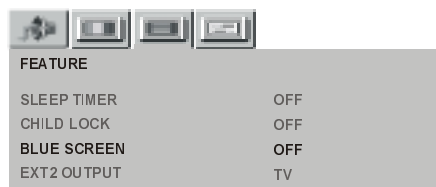

EXT2 Output

From EXT2 Output, either **TV, EXT-1, EXT-3, FRONT-AV** can be given. **TV, EXT-1, EXT-3, FRONT-AV** can be selected by pressing "◀" or "▶" button on "EXT2 OUTPUT".

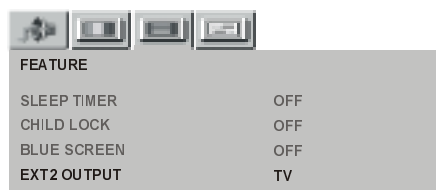

To Store the Settings

- All settings are stored automatically in Feature menu. There is no need to press "OK" button.

Installation Menu

By pressing "◀" or "▶" button, select the fourth icon.



By pressing "▼" or "OK" button, Installation menu appears on the screen. You can enter installation menu directly by pressing BLUE button.



Language

By pressing "▲" or "▼" button, select Language. You can select the language by pressing "◀" or "▶" button.

Country

By pressing "▲" or "▼" button, select Country. You can select the country by pressing "◀" or "▶" button.

Txt Language

By pressing “▲” or “▼” button, select Txt Language. You can select the Teletext Language by pressing “◀” or “▶” button. The options are West Europe, East Europe, Greek-Turkey, Russian.

WEST EUROPE	EAST EUROPE	GREEK-TURKEY	RUSSIAN
ENGLISH	FRENCH	ENGLISH	CZECH/SLOVAK
FRENCH	SWEDISH	FRENCH	GERMAN/DUTCH
SWEDISH	FINNISH	SWEDISH	RUSSIAN
FINNISH	DANNISH	FINNISH	BYLORUSSIAN
DANNISH	CZECH/SLOVAK	DANNISH	LITHUANIAN
CZECH/SLOVAK	GERMAN/DUTCH	GERMAN/DUTCH	LETTISH
GERMAN/DUTCH	ITALIAN	PORTUGUESE	UKRANIAN
PORTUGUESE	HUNGARIAN	SPANNISH	BULGARIAN
SPANNISH	POLISH	ITALIAN	CROATIAN
ITALIAN		HUNGARIAN	ESTONIAN
HUNGARIAN		TURKISH	
ICELANDIC		GREEK	
SLOVENIAN		ICELANDIC	
RUMANIAN			
NORWEGIAN			

Programming

By pressing “▲” or “▼” button, select Programming. You can enter the programming menu by pressing “▶” button.

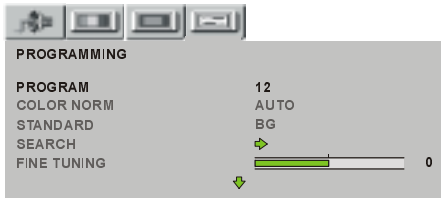

Program

By pressing “◀” / “▶” or digit buttons, select Program. By pressing digit buttons, you can select the program number. There are 100 program storage between 0 and 99.

Color Norm

By pressing “▲” or “▼” button, select Color norm. By pressing “◀” or “▶” button, you can change the standard to **AUTO**, **PAL** or **SECAM**.

Standard

By pressing “▲” or “▼” button, select Standard. By pressing “◀” or “▶” button, you can change the standard to **BG**, **L**, **DK** or **AUTO**.

Search

By pressing “▲” or “▼” button, select Search. By pressing “▶” button, you can enter Search menu.

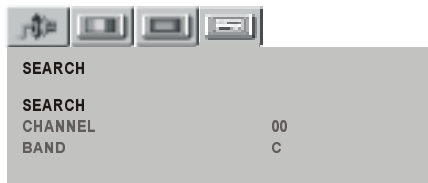

Search

By pressing “▲” or “▼” button, select Search. By pressing “▶” button, you can start Channel Search. When you start the channel searching “SEARCHING...” is written and when a channel is found which has been searched, “FOUND” message is written across the **Search** item in the menu above.

Channel

By pressing “▲” or “▼” button, select Channel. By pressing “◀” / “▶” or digit buttons, you can change the channel number.

Band

By pressing “▲” or “▼” button, select Band. By pressing “◀” or “▶” button, you can change the Band to **C** or **S**.

To exit the Search menu, press “MENU” button.

To Store the Settings

- Press “OK” button to store Search menu settings.
- “STORED” will be displayed.

Fine Tuning

By pressing “▲” or “▼” button, select Fine Tuning. By pressing “◀” or “▶” button, you can fine tune the program manually.



Name

By pressing “▲” or “▼” button in Programming menu, select **NAME**. You can change the program name. When you select the Name, cursor is on the first letter. By using “▲” or “▼”, buttons you can select the letter. By pressing “◀” or “▶” button, you can move the cursor to second or third letter of the program name. Name can be 5 digit length.

To Store the Settings

- Press “OK” button to store Programming menu settings.
- “STORED” will be displayed.
- Press “MENU” button to exit programming menu.

Execution APS

By pressing “▲” or “▼” button, select Execution APS in Programming menu. By pressing “▶” button, you can enter Execution APS menu.

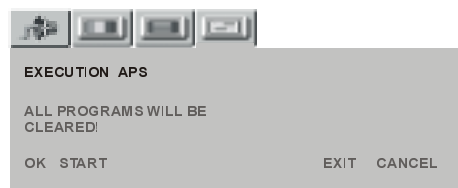

If you want to cancel APS, press “EXIT” button, you return to Installation menu. If “OK” button is pressed, APS function starts and the following menu comes to the screen.



After APS is completed, the **PROGRAM TABLE** is displayed.

PROGRAM TABLE		
1	11	21
2	12	22
3	13	23
4	14	24
5	15	25
6	16	26
7	17	27
8	18	28
9	19	29
10	20	30

change
delete

- Press "EXIT" button to exit Program Table.

Other Functions

Sound Mute

To cut off the sound of the TV press "MUTE" button. The sound will be cut off. To cancel mute, press "MUTE" or "V-" or "V+" button. The volume level will be the same as the level before mute if you cancel mute pressing "MUTE" button again.

Stereo / Bilingual

- If the TV channel you are watching broadcasts in two languages (e.g. Eurosport), you can select the dubbed or the original language, pressing the "DUAL" button.
- When the stereo broadcast is received poorly, you can change from stereo to mono sound so that you can hear the broadcast more clearly and easily.

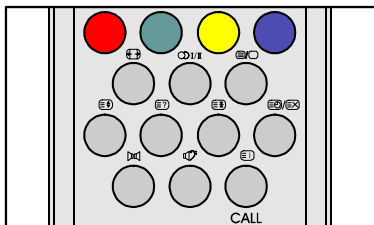

Information on Screen

Pressing the "CALL" button **Program Table** is displayed.

Manual Selection of External Source

The external sources are selected with "SOURCE" button. The external sources are selected sequentially, after each press of the "SOURCE" button. The mode returns to TV mode, either by pressing the "EXIT" button or by pressing the "SOURCE" button, after the last source has been selected. You can also return to channel you were in before entering AV mode by simply pressing "RETURN" button.

Pressing "AV" button on the remote control selects one of AV modes (**EXT-1, EXT-2, EXT-3, S-VHS, S-VHS EXT2 and FRONT-AV**).

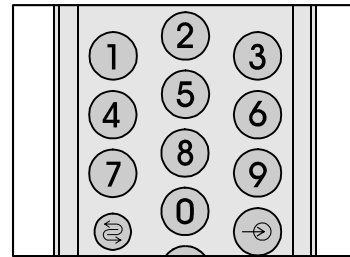

Screen Format

You can switch between the Picture Modes by pressing the "PICTURE" button.

Screen Format can be selected as **AUTO, 4:3 or 16:9**.

In AUTO mode the WSS info is decoded and the mode of the screen format (4:3 or 16:9) is selected automatically by the TV, itself.

Previous Program Selection

By pressing "PREV" button you can switch between the previously selected and last selected TV channel in a toggling mode.

Sound Standard Selection

"DUAL" button on the remote control is used to select Mono/stereo or one of the available languages. The exact response of this button depends on the signal being received.

Received audio signal Response

Received audio signal	Response
Mono	No other choice is possible
German stereo	Toggle between stereo and Mono mode
German dual language	Toggle between language I and II
NICAM Mono	Toggle between the NICAM and the FM carrier signal
NICAM stereo	Toggle between the NICAM stereo and the FM carrier signal
NICAM dual language	Select sequential NICAM language I II FM carrier signal

To Display the Time

- Press "TIME" button on the remote control to display the time. The current time is received from teletext and displayed at the upper left corner of the screen.
- Press "TIME" button again to erase the display.

Picture Mode

Press the "PP" button repeatedly to view the different picture modes available.

Picture modes **1 to 3** are preset options.

Picture mode **M** will contain your own selection of Contrast, Brightness and Colour.

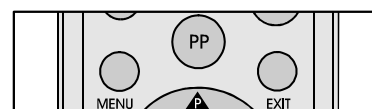

Still Picture

Pressing "OK" button makes the picture on the screen frozen. Pressing this button again enables moving pictures again.

Teletext

Teletext is an information system that displays text on your TV screen. Using the Teletext information system you can view a page of information on a subject that is available in the list of contents (index).

No on screen display will be available in text mode.

While no teletext information available in the selected programme, if you press (teletext) "⊞/⊝" button, 'No Teletext Transmission' warning appears at the center of the screen.

No contrast, brightness or colour control, but volume control is available in text mode.

To operate Teletext

- Select a TV station on which Teletext is being transmitted.
- Press (teletext) "⊞/⊝" button. Usually the list of contents (index) is displayed on the screen.

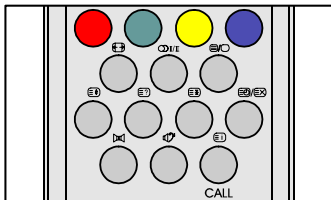

To select a page of Teletext

- Press the appropriate digit buttons for the required Teletext page number.

The selected page number is displayed at the top left corner of the screen. The Teletext page counter searches until the selected page number is located, so that the desired page is displayed on the screen.

- Press "▲" button to move the Teletext screen forward one page at a time.
- Press "▼" button to move the Teletext screen backward one page at a time.

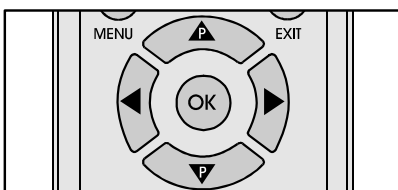

To Select Index Page

- To select the page number of the index (generally page 100), press "⊞" button.

Searching for a page while watching TV

- While Teletext Mode is on, pressing "⊞/⊝" will change the mode to TV, one more press to "⊞/⊝" will change the mode from TV to the latest Teletext page we left. In the TV mode enter a page number using digit buttons. The page number entered will blink on top of the screen until the re-

quested page is found. Then the the page number entered will stop blinking to indicate that page has been found. Now you can display this teletext page pressing "⊞/⊝" button.

To Select Double Height Text

- Press "⊞" button for the top half of the information page to be displayed in double height text.
- Press "⊞" button again for the bottom half of the information page to be displayed in double height text.
- Press "⊞" button once more for the full page of normal height text.

To Reveal "concealed" Information

- Pressing "⊞" button once will reveal answers on a quiz or games page.
- Pressing "⊞" button again will conceal the revealed answers.

To Stop Automatic Page Change

The teletext page you have selected may contain more information than what is on the screen; the rest of the information will be displayed after a period of time.

- Press "⊞" button to stop the automatic page change.
- Press "⊞" button again to allow the next page to be displayed.

Split Screen

- Press "⊞/⊝" button while Teletext mode is active. The screen is divided into two parts. The TV program is displayed on the left side and the text is displayed on the right side of the screen.

To exit Teletext

- Press "⊞/⊝" button twice or press "EXIT" button while Teletext mode is active. The screen will switch to TV mode.

Fastext

Your TV supports the 10 page Teletext system. When the page number of any of the 10 pages in memory is entered, the system will not search for the requested page; instead it will display the page automatically.

- Press "▲" button to move the Teletext screen forward one page at a time.
- Press "▼" button to move the Teletext screen backward one page at a time.

For Fastext

The subject-heading for the information may have a particular colour.

- Press the appropriate color button (RED, GREEN, YELLOW, BLUE) button in order to reach the relevant page quickly.

Connect the External Equipments

Before connecting anything

- Switch off all equipments including the TV.
- Read the manuals provided with the equipments.

To select an AV mode

Pressing "↻" button on the remote control selects one of AV modes (**EXT-1, EXT-2, EXT-3, S-VHS, S-VHS EXT2 and FRONT-AV**).

- To return to the **TV** mode, repeatedly press "↻" button.

EXT.1 terminal: Euroconnector (21-pin, SCART) (Decoder,.....)

- Video input, Audio L/R inputs and RGB inputs are available.
- TV broadcast outputs (Video and Audio L/R) are available.

EXT.2 terminal: Euroconnector (21-pin, SCART) (DVB, DVD,.....)

- Video and Audio L/R outputs are available.
- Video input, S-VIDEO (Y/C) input and Audio L/R inputs are available.

EXT.3 terminal: Euroconnector (21-pin, SCART) (Decoder,.....)

- TV broadcast outputs (Video and Audio L/R) are available.

Front AV terminal: RCA connectors x 3

- Video input and Audio L/R inputs are available.

S-VHS terminal:

- S-VIDEO (Y/C) input.

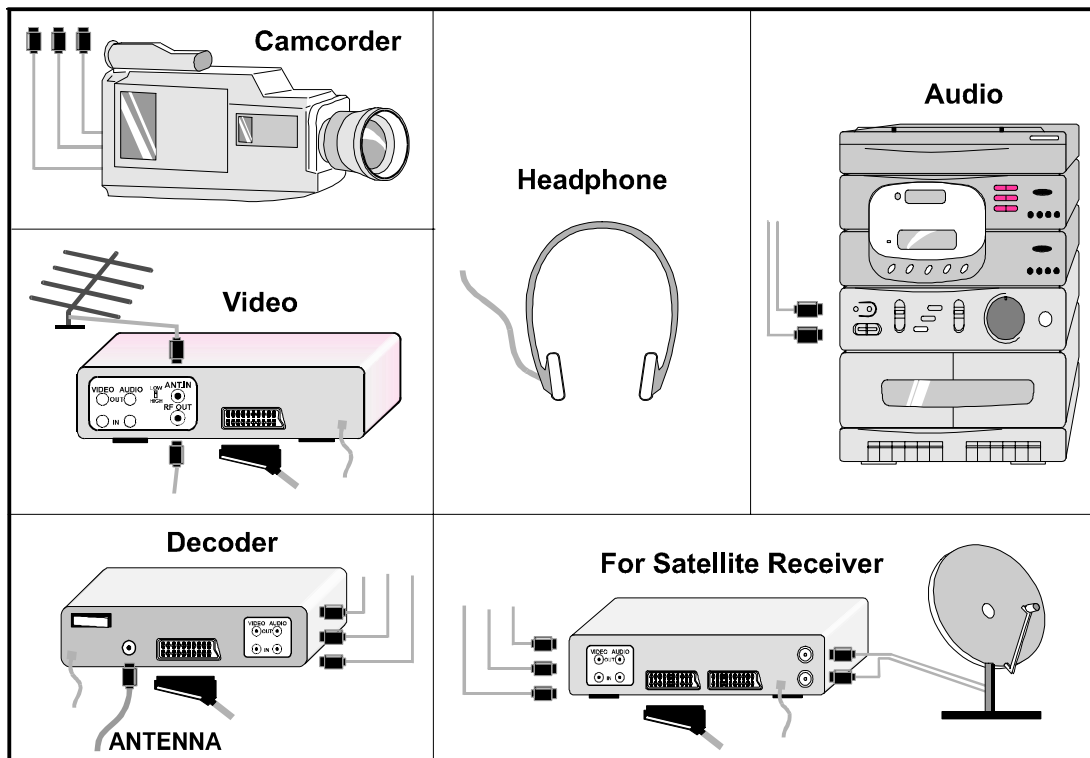
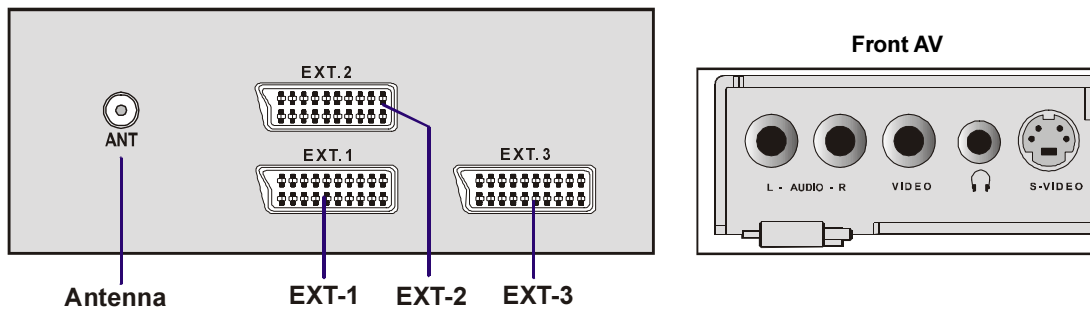

Connect the External Equipments

Via the Euroconnector

Your TV set has three Euroconnector sockets. If you want to connect equipments (e.g. video recorder, decoder, etc.) which have Euroconnectors, to your TV, use the **EXT-1 (EXT.1)**, **EXT-2 (EXT.2)** or **EXT-3 (EXT.3)** terminals.

If an external device is connected via Euroconnector sockets TV is switched to AV mode automatically.

RGB mode

If your equipment supports RGB output, connect it to the **EXT-1 (EXT.1)** terminal.

S-VHS

If the equipment connected to your TV set supports **S-Video (Y/C)** output from **S-VHS** connector, you can enjoy better picture quality by selecting **S-VHS** mode and connecting your equipment to the **S-VHS** terminal of TV.

S-VHS and **FRONT-AV** will share the same audio sockets. In fact there will be only one pair audio channel as audio left and audio right. Also do not use S-VHS and FRONT-AV at the same time.

S-VHS EXT2 Mode

If the equipment connected to your TV set supports S-Video (Y/C) output from Euroconnector, You can enjoy better picture quality by selecting **S-VHS EXT2** mode and connecting your equipment to the **EXT.2** terminal of TV. See your equipment's booklet to check if your equipment has such feature.

Via the RCA jacks

If you have an equipment (such as a Camcorder) which has the RCA jacks, connect it to the **FRONT-AV** terminal with the video and audio cables.

- If the equipment has the mono audio jack, connect it to the **AUDIO-L** jack.

Via the ANT (aerial) socket

If your equipment does not have a Euroconnector or RCA jacks, connect it to the TV with an aerial cable. For details, see the manual provided with the equipment.

TV and Video Recorder (VCR)

- Connect the Video Recorder to the ANT (antenna input) socket of the TV with the aerial cable.
- Connect the Video Recorder to the **EXT-1**, **EXT-2** or **EXT-3** terminal with the SCART cable, or connect it to the **FRONT-AV** terminal with the audio and video cables.
- VCR signal is automatically detected by TV itself.

NTSC Playback

Connect a NTSC video recorder to a terminal. Then press "⊖" button to select the corresponding AV mode.

NTSC 3.58/4.43 system is detected automatically in AV mode.

Copy Facility

You can output the video and audio signals which inputs from **TV**, **EXT-1**, **EXT-3**, **FRONT-AV** terminal to the video recorder connected to the **EXT.2** terminal.

- To select the output source, see "EXT2 OUTPUT" on page 9.

Connecting Headphones

Use the stereo headphone socket of your TV, to connect headphones.

Tips

Care of the Screen

Clean the screen with a slightly damp, soft cloth. Do not use abrasive solvents as they may damage the TV screen coating layer.

Poor Picture

Have you selected the correct TV system? Is your TV set or house aerial located too close to the loudspeakers, non-earthed audio equipment or neon lights, etc. ?

Mountains or high buildings can cause double pictures or ghost images. Sometimes you can improve the picture quality by changing the direction of the aerial.

The picture quality may degrade when two peripherals are connected to the TV at the same time. In such a case, disconnect one of the peripherals.

No Picture

Is the aerial connected properly? Are the plugs connected tightly to the aerial socket? Is the aerial cable damaged? Are suitable plugs used to connect the aerial? If you are in doubt, consult your dealer.

No Picture means that your TV is not receiving any transmission. Have you pressed the correct buttons on the remote control? Try once more.

Sound

Sound is coming from only one of the speakers. Is the balance set to one direction extreme? See **SOUND** menu.

Remote Control

Your TV no longer responds to the remote control. Press the "EXIT" button on the remote control once more. Perhaps the batteries are exhausted. If so you can still use the local buttons at the front of your TV.

Have you selected the wrong menu? Press "EXIT" button to return to TV mode or press "MENU" button to return to the previous menu.

No solution

Switch your TV set off and on. If this does not work, withdraw the mains plug and call the service personnel; never attempt to repair it yourself.

Cleaning The Screen

Your TV is fitted with a „True Flat“ picture tube. The surface of the screen is covered with a foil. Under no circumstances may this be damaged.

To clean

Clean the laminated screen or cabinet with a soft cotton cloth. Only non-alkaline, thinned soapsuds and water can be used to moisten the cloth. Rub the surface gently with the cloth until the surface is completely dry.

Under no circumstances...

May the screen be wiped with conventional glass cleaning fluid.

May the screen be brought into contact with abrasive materials.

May soiling be removed by polishing or scouring.

Exclusion Clause

Toshiba shall under no circumstances be liable for loss and/or damage to the product caused by:

- i) fire;
- ii) earthquake;
- iii) accidental damage;
- iv) intentional misuse of the product;
- v) use of the product in improper conditions;
- vi) loss and/or damage caused to the product whilst in the possession of a third party;
- vii) any damage or loss caused as a result of the owner's failure and/or neglect to follow the instructions set out in the owner's manual;
- viii) any loss or damage caused directly as a result of misuse or malfunction of the product when used simultaneously with associated equipment;

Furthermore, under no circumstances shall Toshiba be liable for any consequential loss and/or damage including but not limited to the following, loss of profit, interruption of business, the loss of recorded data whether caused during normal operation or misuse of the product.

WARNING! NEVER LEAVE A STATIONARY IMAGE ON THE SCREEN

If stationary images generated by TELETEXT, CHANNEL IDENTIFICATION LOGOS, COMPUTER DISPLAYS, VIDEO GAMES, ON SCREEN MENUS, etc. are left on the TV screen for any length of time, they could become permanently ingrained.

If you use your television to display completely still images, or moving pictures which have a permanent still image superimposed e.g. broadcast network logos, it is always advisable to reduce BOTH the brightness and contrast settings;

Disposal...

When the set reaches the end of its useful life please dispose of it in accordance with Local Government Regulations or at a recycling centre.

Specifications

TV BROADCASTING

PAL SECAM B/G D/K L/L'

RECEIVING CHANNELS

VHF (BAND I/III)

UHF (BAND U)

HYPERBAND

CABLE TV ➡ **B/G** : S01-S41 / S75-S79

D/K : S01-S41

L(L') : S01-S41 / S75-S77

NUMBER OF PRESET CHANNELS

100

CHANNEL INDICATOR

On Screen Display

RF AERIAL INPUT

75 Ohm (unbalanced)

OPERATING VOLTAGE

230V AC, 50 Hz.

AUDIO OUTPUT

German + Nicam Stereo

AUDIO OUTPUT POWER (W_{RMS}) (%10 THD)

2 x 10

POWER CONSUMPTION (W) (max.)

148

ST-BY POWER CONSUMPTION (W)

<3

PICTURE TUBE

29" (680 mm)

DIMENSIONS (mm)

DIMENSIONS (mm)			
D	L	H	Weight (kg)
496	785	583	46